

HSCM Series

Carbon Monoxide Sensors

Honeywell HSCM series carbon monoxide sensors are mainly used to detect carbon monoxide concentration in indoor air where carbon monoxide is generated in parking lots and other places. The sensors can output analog signals and switching signals, and can also transmit detection data through the Modbus RTU protocol for ventilation control.



Features

- Use eco-friendly electrochemical carbon monoxide sensor.
- Optional display function, LCD digital display shows clearly.
- Optional alarm relay output, and the alarm concentration value can be set by dip switches.
- Multiple software and hardware protection design ensures high stability.
- Integrated RS485 terminal resistor to facilitate on-site debugging (Modbus models only).
- RS485 isolation design can isolate high voltage and enhance immunity to ground loops and common-mode signal interference (Modbus models only).

Order Information and Technical Specification

SKU	Measuring Range	Analog Output or Protocol	Display	Alarm Relay Output
HSCM-R100U	0-100PPM	0-10V/2-10V//4-20mA	NO	NO
HSCM-R100UL	0-100PPM	0-10V/2-10V//4-20mA	YES	NO
HSCM-R100US	0-100PPM	0-10V/2-10V//4-20mA	NO	YES
HSCM-R100ULS	0-100PPM	0-10V/2-10V//4-20mA	YES	YES
HSCM-R100M	0-100PPM	Modbus RTU	NO	NO
HSCM-R100ML	0-100PPM	Modbus RTU	YES	NO
HSCM-R400U	0-400PPM	0-10V/2-10V//4-20mA	NO	NO
HSCM-R400UL	0-400PPM	0-10V/2-10V//4-20mA	YES	NO
HSCM-R400US	0-400PPM	0-10V/2-10V//4-20mA	NO	YES
HSCM-R400ULS	0-400PPM	0-10V/2-10V//4-20mA	YES	YES
HSCM-R400M	0-400PPM	Modbus RTU	NO	NO
HSCM-R400ML	0-400PPM	Modbus RTU	YES	NO

Basic Parameters

Sensing element	Eco-friendly electrochemical carbon monoxide sensor
Measuring Range	0 to 100PPM or 0 to 400PPM
Accuracy @ 25°C	±5PPM or ±5% of measuring value greater
Repeatability	±2%
Stability	≤ 5% / Year Signal attenuation
Zero Point Drift (Based on temperature)	≤±10PPM @ 0°C to 50°C
Display Resolution	1PPM
Responding Time (T90)	No more than 45 Seconds
Power Supply	24VDC ±20%; 24VAC ± 20%, 50/60Hz Class 2/ SELV
Power Consumption	1VA MAX
Analog Output	0-10V, 2-10V, 4-20mA, select by DIP Setting
Analog Output Load	4-20mA: ≤500 Ω, Current Consumption≤ 20mA 0-10V/2-10V: ≥5 KΩ, Current Consumption≤1mA
Analog Output Resolution	Modbus: 1 PPM 0-10V/2-10V: 25 mV 4-20mA: 0.04mA
Alarm relay output settings	0-100PPM: 25PPM, 60PPM or 80PPM by DIP setting 0-400PPM: 25PPM, 60PPM or 150PPM by DIP setting The relay alarm output is off by default, and a DIP switch needs to be set to activate the relay alarm.. After the alarm is generated, the alarm will be cleared when the carbon monoxide concentration value is 9PPM (maximum value) or 3% below the set value.
Relay Specification	1x SPDT, 2A / 30 VDC, 0.5A/125VAC Resistive load
Number of connected Modbus RTU devices	A maximum of 64 devices can be connected to a single network segment
Operation Environment	-20°C to 50°C, 15% to 90% RH (Non-condensing)
Operation Atmospheric Pressure	0.9 to 1.1 times standard atmospheric pressure
Storage Environment	-20°C to 50 °C, 15% to 95% RH (Non-condensing)
Protection Standard	IP30 (GB4208/IEC60529)
Maximum Service Life	More than 7 years
Housing Materials	PC (UL94-V0)
Certification	CE (EN IEC 61326-1:2021); China RoHS

Function & DIP Setting

A. Analog Output Type

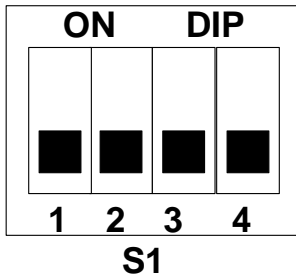

DIP No.	No. S1-1	Do.S1-2 & Do. S1-3	No. S1-4
Function	Calibration (Only for production process)	Analog output option	Reserved

Select analog output signal type: DIP No. S1-2 and No. S1-3																											
DIPs Position	<p>ON DIP</p> <table border="1"> <tr> <td><input type="checkbox"/></td> <td><input checked="" type="checkbox"/></td> <td><input checked="" type="checkbox"/></td> <td><input type="checkbox"/></td> </tr> <tr> <td>1</td> <td>2</td> <td>3</td> <td>4</td> </tr> </table> <p>S1</p>	<input type="checkbox"/>	<input checked="" type="checkbox"/>	<input checked="" type="checkbox"/>	<input type="checkbox"/>	1	2	3	4	<p>ON DIP</p> <table border="1"> <tr> <td><input type="checkbox"/></td> <td><input checked="" type="checkbox"/></td> <td><input checked="" type="checkbox"/></td> <td><input type="checkbox"/></td> </tr> <tr> <td>1</td> <td>2</td> <td>3</td> <td>4</td> </tr> </table> <p>S1</p>	<input type="checkbox"/>	<input checked="" type="checkbox"/>	<input checked="" type="checkbox"/>	<input type="checkbox"/>	1	2	3	4	<p>ON DIP</p> <table border="1"> <tr> <td><input type="checkbox"/></td> <td><input checked="" type="checkbox"/></td> <td><input checked="" type="checkbox"/></td> <td><input type="checkbox"/></td> </tr> <tr> <td>1</td> <td>2</td> <td>3</td> <td>4</td> </tr> </table> <p>S1</p>	<input type="checkbox"/>	<input checked="" type="checkbox"/>	<input checked="" type="checkbox"/>	<input type="checkbox"/>	1	2	3	4
<input type="checkbox"/>	<input checked="" type="checkbox"/>	<input checked="" type="checkbox"/>	<input type="checkbox"/>																								
1	2	3	4																								
<input type="checkbox"/>	<input checked="" type="checkbox"/>	<input checked="" type="checkbox"/>	<input type="checkbox"/>																								
1	2	3	4																								
<input type="checkbox"/>	<input checked="" type="checkbox"/>	<input checked="" type="checkbox"/>	<input type="checkbox"/>																								
1	2	3	4																								
Analog Output	4-20mA (Default)	0-10V	2-10V																								

B. Analog and Alarm Relay Output Type

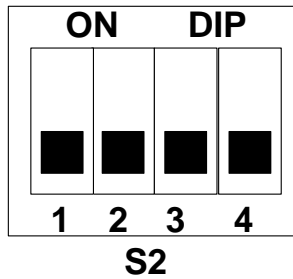
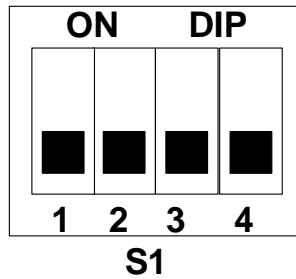

DIP No.	No. S1-1	Do.S1-2 & Do. S1-3	No. S1-4 & No. S2-1	No. S2-2 to No. S2-4
Function	Calibration (Only for production process)	Analog output option	Set carbon monoxide concentration alarm value	Reserved

Select analog output signal type: DIP No. S1-2 and No. S1-3																											
DIPs Position	<p>ON DIP</p> <table border="1"> <tr> <td><input type="checkbox"/></td> <td><input checked="" type="checkbox"/></td> <td><input checked="" type="checkbox"/></td> <td><input type="checkbox"/></td> </tr> <tr> <td>1</td> <td>2</td> <td>3</td> <td>4</td> </tr> </table> <p>S1</p>	<input type="checkbox"/>	<input checked="" type="checkbox"/>	<input checked="" type="checkbox"/>	<input type="checkbox"/>	1	2	3	4	<p>ON DIP</p> <table border="1"> <tr> <td><input type="checkbox"/></td> <td><input checked="" type="checkbox"/></td> <td><input checked="" type="checkbox"/></td> <td><input type="checkbox"/></td> </tr> <tr> <td>1</td> <td>2</td> <td>3</td> <td>4</td> </tr> </table> <p>S1</p>	<input type="checkbox"/>	<input checked="" type="checkbox"/>	<input checked="" type="checkbox"/>	<input type="checkbox"/>	1	2	3	4	<p>ON DIP</p> <table border="1"> <tr> <td><input type="checkbox"/></td> <td><input checked="" type="checkbox"/></td> <td><input checked="" type="checkbox"/></td> <td><input type="checkbox"/></td> </tr> <tr> <td>1</td> <td>2</td> <td>3</td> <td>4</td> </tr> </table> <p>S1</p>	<input type="checkbox"/>	<input checked="" type="checkbox"/>	<input checked="" type="checkbox"/>	<input type="checkbox"/>	1	2	3	4
<input type="checkbox"/>	<input checked="" type="checkbox"/>	<input checked="" type="checkbox"/>	<input type="checkbox"/>																								
1	2	3	4																								
<input type="checkbox"/>	<input checked="" type="checkbox"/>	<input checked="" type="checkbox"/>	<input type="checkbox"/>																								
1	2	3	4																								
<input type="checkbox"/>	<input checked="" type="checkbox"/>	<input checked="" type="checkbox"/>	<input type="checkbox"/>																								
1	2	3	4																								
Analog Output	4-20mA (Default)	0-10V	2-10V																								

Function & DIP Setting

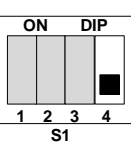
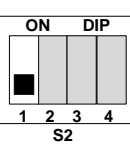
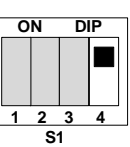
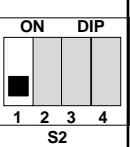
Set carbon monoxide concentration alarm value : DIP NO. S1-4 and No. S2-1				
DIP Position				
0 to 100PPM	Disable (Default)	25PPM	60PPM	80PPM
0 to 400PPM	Disable (Default)	25PPM	60PPM	150PPM

C. Modbus Communication Type

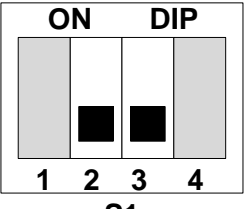
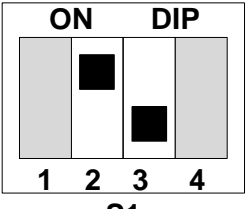
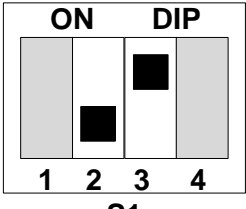
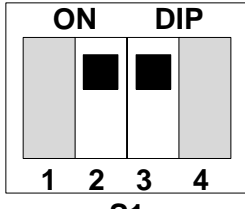

DIP No.	No. S1-1	No. S1-2 & No. S1-3	No. S1-4 to No.S3-2	No. S3-3	No. S3-4
Function	Calibration (Only for production process)	Modbus Baud Rate	Modbus Address	Reserved	RS485 Terminal Resistor

Set Modbus Baud Rate: DIP No.S1-2 and No. S1-3				
DIPs Position				
Baud Rate	9600 (Default)	4800	19200	38400

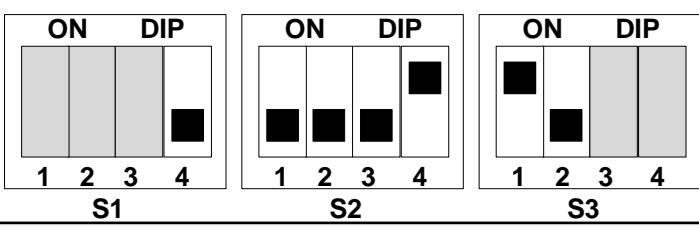
Set Modbus address: DIP No. S1-4 to No. S3-2	
DIPs Position	
How to set Modbus address	<ol style="list-style-type: none"> DIPs No. S1-4 to No. S3-2 represent 1, 2, 4, 8, 16, 32 and 64 respectively. DIPs up to indicate selected number The sum of the selected numbers is the Modbus address code. As shown in the picture above: DIP No. S2-4 and No. S3-1 are selected, $16+32=48$, so the address code setting value is 48.

Set the mode of RS485 terminal resistor: DIP No.S3-4		
DIP Position		
Mode	Enable (Default)	Disable

Modbus RTU Protocol

Register Address Information

ID	ID function	Function	Qty.	Readable (R) /Writable (W)	Data Type
0x01	Gas Concentration	Current gas concentration Unit: PPM	1	R	short
0x02	Reserved		1	R	short
0x03	Reserved		1	R	short
0x04	Reserved		1	R	short
0x05	Reserved		1	R	short
0x06	Reserved		1	R	short
0x07	Reserved		1	R	short
0x08	Running time	Unit: day	1	R	short
0x09	Error Code	0=Normal; 2=System Error	1	R	short

Function Code Information

Code	Function	Error Code	Exception Code
0x03	Read holding register	0x83	01 or 02 or 03
0x06	Write single register	0x86	01 or 02 or 03
0x10	Write Multiple Registers	0x90	01 or 02 or 03

Dimension (mm)

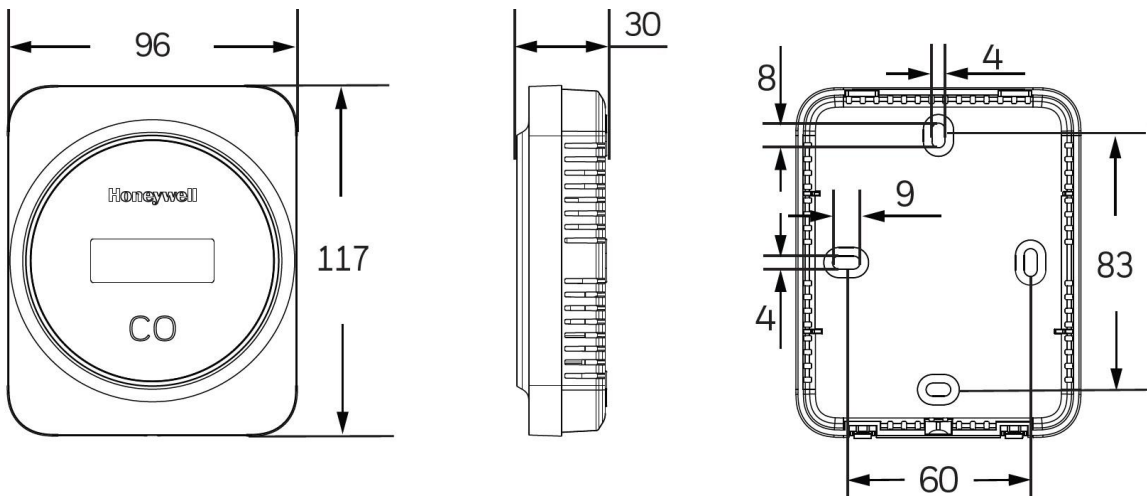

Wiring diagrams and instructions

0-10V/2-10/4-20mA Analog Output Type

SKU
HSCM-R100U
HSCM-R100UL
HSCM-R400U
HSCM-R400UL



Modbus Communication Type

SKU
HSCM-R100M
HSCM-R100ML
HSCM-R400M
HSCM-R400ML

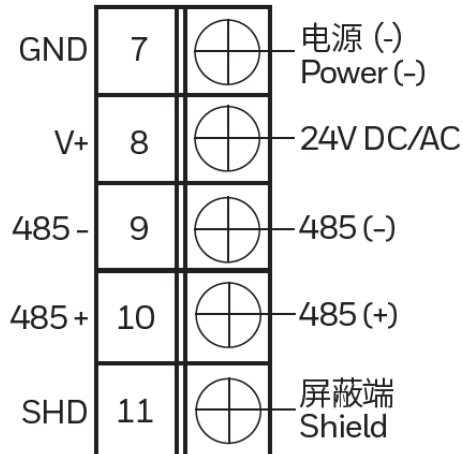

Analog and Alarm Relay Output Type

SKU
HSCM-R100US
HSCM-R100ULS
HSCM-R400US
HSCM-R400ULS

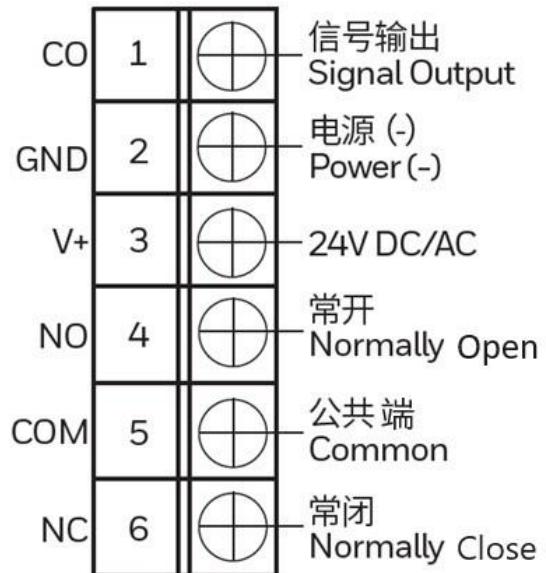

Tip: When the alarm is output, the NO point is turned on.

Tips:

1. The terminals support AWG15 to AWG22 line types.
2. The maximum lengths of different conductors are as follows.

Line Type	AWG15	AWG16	AWG17	AWG18	AWG20	AWG22
Max length	300 Meters	300 Meters	150 Meters	150 Meters	150 Meters	50 Meters

3. RS485 wiring requires a shielded cable with a maximum allowable length of 1200 meters.

Installation, Application and Responsibility Statement

1. Please read the sensor installation instructions carefully before installing and commissioning the device. Operation and application not in accordance with installation instructions may result in product failure and damage. Please comply with local laws, health and safety regulations, technical standards and regulations.
2. It is prohibited to be used in explosive or hazardous environments, prohibited to be used in flammable or flammable gas environments, and prohibited to be used as a safety or emergency stop device. Improper application may cause personal injury and loss.
3. Pay attention to anti-static during installation.
4. Carbon monoxide sensors should be installed at a reasonable height and meet relevant regulatory requirements. Do not install the sensor near doors, windows, air outlets or other known air disturbances. Avoid areas with vibration or rapid temperature changes.
5. RS485 communication lines need to be shielded wires. Do not place communication lines and cables in the same pipe. Please disconnect the power supply before making any connections to prevent electrical faults, electric shock or equipment damage. Make all connections in accordance with national and local codes.
6. When connecting multiple devices, pay attention to the polarity of the power supply to avoid damage to the devices.
7. The sensor is a precision device. If the transportation conditions are poor or the installation is improper, the sensor components may be permanently damaged and the accuracy cannot be guaranteed.
8. For applications that require higher sensor accuracy, be sure to calibrate regularly. It is recommended to recalibrate every 6 to 12 months.
9. For use beyond the technical specifications marked on this product, please consult Honeywell. Honeywell assumes no liability for damages resulting from incorrect application of its products.
10. The carbon monoxide sensor will be interfered by the gas below and affect the measurement accuracy, so it needs to be paid attention to in the application.

interfering gas	Test concentration (PPM)	Equivalent reading value
Carbon monoxide	100	100
Hydrogen	500	200
Methane	5000	0
Iso-butane	2500	0
Carbon dioxide	5000	0
Carbon di-sulfide	25	0
Hydrogen sulfide	10	0
Nitric oxide	30	0
Nitrogen dioxide	30	<30
Ammonia	100	0
Ethyl acetate	200	0
Heptane	500	0
Ethanol	2000	<30 (Exposure time is 30 minutes)
Hexa-methyl di-siloxan	10	0 (Exposure time is 40 minutes)



Honeywell Building Technologies
Greater China Building Business
Website: www.honeywell.com.cn
Service Hotline: 400-842-8487

© 2023 Honeywell International Inc.
All specifications are subject to change without

**THE
FUTURE
IS
WHAT
WE
MAKE IT**

Honeywell