

MICRO SWITCH Miniature Precision Limit Switches

914CE Series

002381

Issue 7

Datasheet



DESCRIPTION

All MICRO SWITCH 914CE Series compact enclosed switches incorporate fluorocarbon diaphragm sealing to provide reliable protection, meeting NEMA 1, 2, 3, 3R, 4, 6, 6P, and 13, as well as IP66, IP67, and IP68 requirements. Versions with a boot seal also meet NEMA 12 requirements (dust, falling dirt, liquid media with solid contaminants). The cable or connector and basic switch terminals are encapsulated in an epoxy sealant, offering excellent resistance in harsh environments. For low temperature applications (down to -40 °C, -40 °F), CE Series switches can be supplied with low temperature seals and lubricant.

The CE Series switches are rugged and versatile switches which can be applied indoors in many harsh factory floor applications, as well as on outdoor equipment in extreme temperatures. A full range of actuators are available, including plain plungers, roller plungers, side rotary, multi-directional wire, and manually operated. The switches are also available with the industry standard, M12 micro-change 4-pin connector. MICRO SWITCH 914CE products meet North American, cURus standards, as well as European CE requirements.

VALUE TO CUSTOMERS

- Big performance in a small package
- Delivers consistent performance in many demanding environments where petroleum, synthetic, or water based fluids are present
- Configurable product platform for design versatility

FEATURES

- Rugged, compact construction means minimal real estate on equipment
- Die-cast zinc housing and fluorocarbon diaphragm maintain a tightly sealed, NEMA 1, 2, 3, 3R, 4, 6, 6P, 12 (boot seal), 13, and IP66/67/68 package
- Pre-leaded (UL cable) or supplied with a M12 four-pin connector
- Wide selection of actuators, cable length variations, and side and bottom exit cable/connector options
- 25 mm hole-hole mounting footprint engineered with a MICRO SWITCH SM switch for consistent, precise actuation
- Well suited for up to 10 million actuation cycles (Up to 5 million actuation cycles for wobble actuators)
- Gang mounting capability to provide a multi-plunger limit switch
- Low temperature variants available for indoor and outdoor applications
- cURus, CE approvals for world-wide use

POTENTIAL APPLICATIONS

- Machine tools
- Off-road equipment
- Material handling
- Dock locks and dock levelers
- Access and mobility solutions
- Textile machinery
- Robotics
- Packaging equipment
- Commercial appliances
- Print trade machinery
- Agricultural machinery

DIFFERENTIATION

- Diaphragm seal between the actuator and the switch cavity for high performance sealing
- CE series uses MICRO SWITCH SM basic switch for consistent, precise actuation

PORTFOLIO

Honeywell's MICRO SWITCH 914CE limit switch is part of a comprehensive offering of rugged and reliable limit switches. To view the entire product portfolio, click [here](#).

MICRO SWITCH Miniature Precision Limit Switches, 914CE Series

Table 1. Specifications

Characteristic	Parameter
Description	compact enclosed limit switch
Actuators	<ul style="list-style-type: none"> • Top pin plunger (914CE1-) • Cross roller plunger (914CE3-) • Top pin plunger with boot seal (914CE18-) • Wobble (914CE20-) • Top pin plunger, panel mount (914CE27-) • Top roller plunger, parallel and panel mount (914CE28-) • Top roller plunger, perpendicular, panel mount (914CE29-) • Top roller plunger, parallel & boot sealed (914CE31-) • Top roller plunger, perpendicular, boot seal (914CE55-) • Parallel roller plunger (914CE2-) • Front rotary (914CE16-) • Top adjustable plunger (914CE19-) • Manually operated (914CE22-) • Ball bearing plunger (914CE66-)
Terminations	SJTO 4 x 0,75 mm ² (18 AWG) cable Connector (dc), 4-pin male, M12 thread (-Q), (-Q2) Revised pin-out, see page 3 Connector (ac), 4-pin male, 1/2 in x 20 thread (-Q1)
Switching options	SPDT, snap action contacts (1NC/1NO)
Sealing	IP66, IP67, IP68 (depending upon model) NEMA 1, 2, 3, 3R, 4, 6, 6P, 12 (boot seal), 13
Operating temperature	0 °C to 105 °C [32 °F to 221 °F]; optional -40 °C to 105 °C [-40 °F to 221 °F] Rotary: -40° C to 100 °C [-40 °F to 212 °F]
Mechanical life	up to 10 million (up to 5 million for wobbles)
Thermal current	1 A
Rated insulation voltage (Ui)	250 V
Rated impulse withstand voltage (Uimp)	1.5 kV
Short circuit protection device (SCPD)	Quick blow fuse suitable for rated current of switch
Pollution degree	3
Min. actuation speed	0.003 m/s
Max. actuation speed	0.1 m/s
Max. actuation frequency	ac – 200 Hz; dc – 20 Hz
Shock	50 g – IEC 60068-2-27
Vibration	10 g – IEC 60068-2-6
Approvals	cURus, CE
Conforming to standards	IEC 947-5-1, EN 60947-5-1; AC14 D300, DC13 R300 UL recognized to US and Canadian Requirements

Table 2. Electrical Ratings (in amperes)

Model example	Contacts	Rating
914CE* - *	Silver contacts	A
914CE* - *G	Gold contacts	B
914CE* -Q, -AQ, -AQ1, -Q2	Silver contacts	C with 4 pin connector

Rating code	Electrical rating	Make	Break
A	cURus, CE	240 Vac, ind.	1.2
		240 Vac, res.	5
		28 Vdc, res.	3
		28 Vdc, ind.	3
		5 A, 1/10 HP, 125 Vac or 250 Vac	–
B	cURus, CE	1 A res., 0.5 A ind., 30 Vdc 1 A, 125 Vac	–
C	cURus, CE	3 A, 125 Vac or 250 Vac	–

MICRO SWITCH Miniature Precision Limit Switches, 914CE Series

SWITCHING AND LEAD IDENTIFICATION

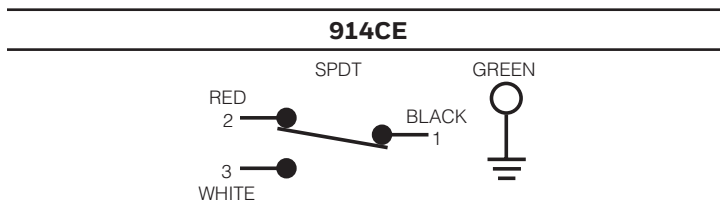

PINOUTS

Connector - (dc) (-Q)	Connector (dc) (-Q2)	Connector (ac) (-Q1)

CONNECTOR VERSIONS

The 914CE Series is available with a 4-pin, M12 size connector in both bottom and side exit versions.

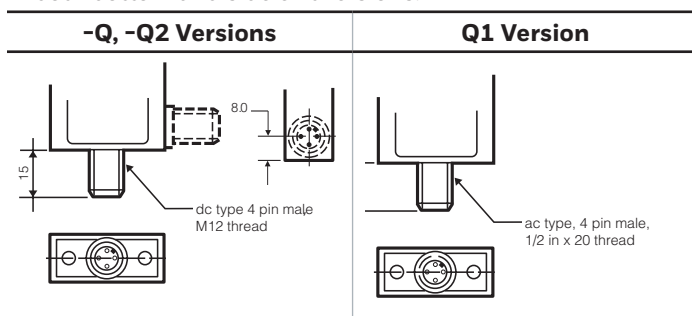

MOUNTING

MICRO SWITCH 914CE Series switches are mounted by using two M5 or #10 screws. The mounting holes are counter bored to keep the screw heads within the overall switch housing dimensions.

GANG MOUNT CAPABILITY

The housing on the 914CE Series has been designed to enable the user to build his own multiple plunger switch by gang mounting several switches. All pin plunger and roller plunger types are suitable for gang mounting. There is a 16 mm distance between the plungers. Both Series types are very versatile that even a lever-type version could be added at the end of the row.

BOTTOM EXIT OR SIDE EXIT ORIENTATION

The CE Series has been designed with a pre-wired cable fitted in the bottom of the switch housing. Other variations are available with a side exit cable.

GOLD CONTACT VERSIONS

For low energy applications (up to 30 Vdc, 1 A), gold contact versions of the 914CE switches can be supplied upon request.

MICRO SWITCH Miniature Precision Limit Switches, 914CE Series

GENERAL DIMENSIONS • ALL SWITCHES

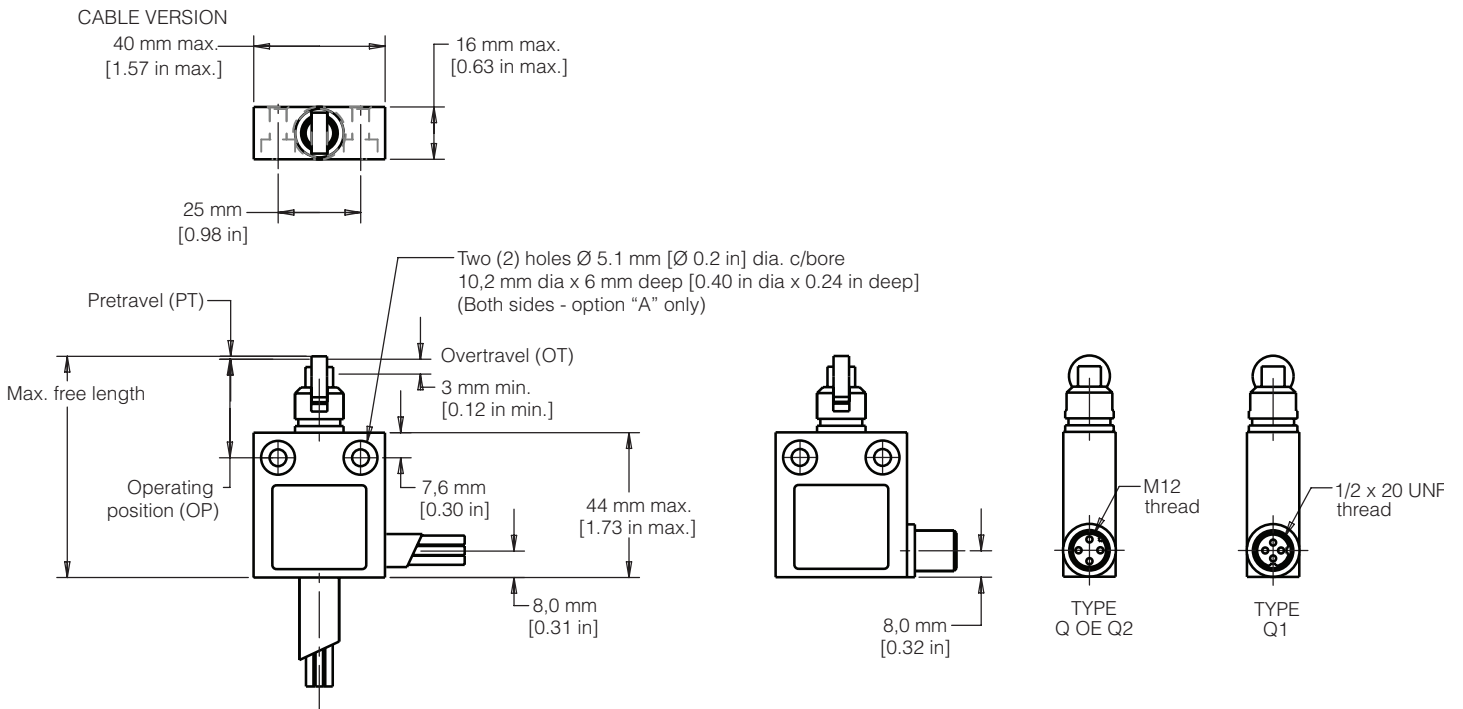

PRODUCT NOMENCLATURE

914CE	29	-	3		
Switch Type	Actuator Type		Cable Length	Options ¹	Connectors
914CE Series Small Precision Limit Switch	1 Top pin plunger	22 Manually oper. nylon button	3 3 feet	A Side entry	Q dc type single keyway
	2 Top roller plunger, parallel	27 Top pin plunger, panel mount	6 6 feet	G Gold contacts	Q1 ac type two keyways
	3 Top roller plunger, perp.	28 Top roller plunger, parallel panel mount	9 9 feet	P Top mounting	Q2 dc type optional pin-out
	16 Front rotary	29 Top roller plunger, perp. panel mount	12 12 feet	L1 Low temp. -40 °C, cable not for flexing	
	18 Top pin plunger w/ boot seal	31 Top roller plunger, parallel boot seal	15 15 feet	V Viton® seals/gasket (front rotary and booted sealed plungers only)	
	19 Top adjustable pin plunger	55 Top roller plunger, perp. boot seal			
	20 Coil wobble	66 Top ball bearing plunger			

Bottom exit is standard.

NOTE: not all combinations of model code are available.
 Please contact your Honeywell provider/representative for assistance.

¹More than one option may be permissible.

MICRO SWITCH Miniature Precision Limit Switches, 914CE Series

PRODUCT SPECIFICATIONS AND LISTINGS

Contact your Honeywell rep or distributor for additional listings

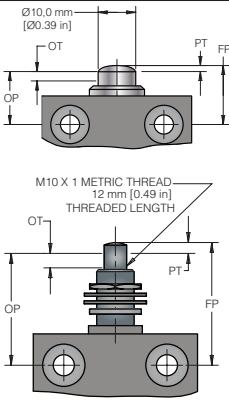
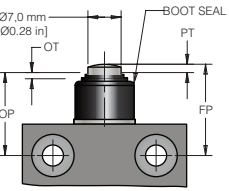
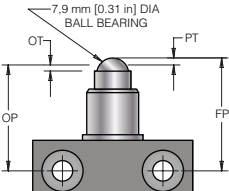
914CE1 • Pin Plunger 914CE27 • Pin Plunger Panel Mount		Contacts	Elec Rating	Cable Exit	Free Position (FP)	Operating Position (OP)	Options	Listing
 <p> Pretravel • 1,8 mm [0.071 in] Diff. travel • 0,1 mm [0.004 in] Overtravel • 3,0 mm [0.118 in] Oper. force • 12,2 N [2.75 in-lb] </p>	Silver	A	Bottom	17,5 mm [0.69 in]	15,7 mm [0.62 in]	–	914CE1-3	
	Gold	B	Bottom	17,5 mm [0.69 in]	15,7 mm [0.62 in]	–	914CE1-3G	
	Silver	A	Side	17,5 mm [0.69 in]	15,7 mm [0.62 in]	–	914CE1-3A	
	Silver	A	Bottom	31,1 mm [1.23 in]	29,3 mm [1.15 in]	Panel mount	914CE27-3	
	Silver	C	Bottom	17,5 mm [0.69 in]	15,7 mm [0.62 in]	dc-type, single keyway	914CE1-Q	
	Silver	C	Bottom	17,5 mm [0.69 in]	15,7 mm [0.62 in]	ac-type, two keyways	914CE1-Q1	
914CE18 • Boot Sealed Pin Plunger		Contacts	Elec Rating	Cable Exit	Free Position (FP)	Operating Position (OP)	Options	Listing
 <p> Pretravel • 1,8 mm [0.071 in] Diff. travel • 0,1 mm [0.004 in] Overtravel • 3,0 mm [0.118 in] Oper. force • 22,2 N [5 in-lb] </p>	Silver	A	Bottom	26,7 mm [1.05 in]	24,9 mm [0.98 in]	–	914CE18-3	
	Silver	A	Side	26,7 mm [1.05 in]	24,9 mm [0.98 in]	–	914CE18-3A	
	Silver	A	Bottom	26,7 mm [1.05 in]	24,9 mm [0.98 in]	Fluorocarbon seals	914CE18-3V	
	Silver	C	Bottom	26,7 mm [1.05 in]	24,9 mm [0.98 in]	ac-type, two keyways	914CE18-Q1	
	Silver	C	Side	26,7 mm [1.05 in]	24,9 mm [0.98 in]	ac-type, two keyways	914CE18-AQ1	
914CE66 • Ball Bearing Plunger		Contacts	Elec Rating	Cable Exit	Free Position (FP)	Operating Position (OP)	Options	Listing
 <p> Pretravel • 1,8 mm [0.071 in] Diff. travel • 0,1 mm [0.004 in] Overtravel • 3,0 mm [0.118 in] Oper. force • 12,2 N [2.75 in-lb] </p>	Silver	A	Bottom	26,2 mm [1.03 in]	24,4 mm [0.96 in]	–	914CE66-3	

MICRO SWITCH Miniature Precision Limit Switches, 914CE Series

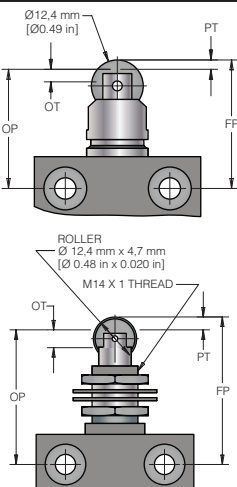
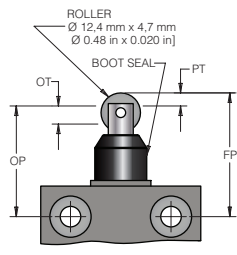
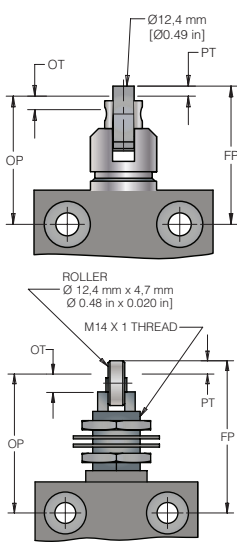
914CE2 • Roller Plunger 914CE28 • Roller Plunger Panel Mount		Contacts	Elec Rating	Cable Exit	Free Position (FP)	Operating Position (OP)	Options	Listing
 <p> Pretravel • 1.8 mm [0.071 in] Diff. travel • 0.1 mm [0.004 in] Overtravel • 3.0 mm [0.118 in] Oper. force • 12.2 N [2.75 in-lb] </p>	Silver	A	Bottom	30,3 mm [1.19 in]	28,5 mm [1.12 in]	–	914CE2-3	
	Gold	B	Bottom	30,3 mm [1.19 in]	28,5 mm [1.12 in]	–	914CE2-3G	
	Silver	C	Bottom	30,3 mm [1.19 in]	28,5 mm [1.12 in]	ac-type, two keyways	914CE2-Q1	
	Silver	C	Bottom	30,3 mm [1.19 in]	28,5 mm [1.12 in]	dc-type, single keyway	914CE2-Q	
	Silver	A	Side	30,3 mm [1.19 in]	28,5 mm [1.12 in]	–	914CE2-3A	
	Silver	A	Bottom	44,3 mm [1.75 in]	42,5 mm [1.67 in]	Panel mount	914CE28-3	
	Silver	C	Bottom	44,3 mm [1.75 in]	42,5 mm [1.67 in]	Panel mount, ac-type, two keyways	914CE28-Q1	
914CE31 • Boot Sealed Roller Plunger		Contacts	Elec Rating	Cable Exit	Free Position (FP)	Operating Position (OP)	Options	Listing
 <p> Pretravel • 1.8 mm [0.071 in] Diff. travel • 0.1 mm [0.004 in] Overtravel • 3.0 mm [0.118 in] Oper. force • 22,2 N [5 in-lb] </p>	Silver	A	Bottom	36,2 mm [1.43 in]	34,4 mm [1.36 in]	–	914CE31-3	
	Silver	A	Bottom	36,2 mm [1.43 in]	34,4 mm [1.36 in]	Fluorocarbon seals	914CE31-3V	
914CE3 • Cross Roller Plunger 914CE29 • Cross Roller Panel Mount		Contacts	Elec Rating	Cable Exit	Free Position (FP)	Operating Position (OP)	Options	Listing
 <p> Pretravel • 1.8 mm [0.071 in] Diff. travel • 0.1 mm [0.004 in] Overtravel • 3.0 mm [0.118 in] Oper. force • 12.2 N [2.75 in-lb] </p>	Silver	A	Bottom	30,3 mm [1.19 in]	28,5 mm [1.12 in]	–	914CE3-3	
	Gold	B	Bottom	30,3 mm [1.19 in]	28,5 mm [1.12 in]	–	914CE3-3G	
	Silver	A	Side	30,3 mm [1.19 in]	28,5 mm [1.12 in]	–	914CE3-3A	
	Silver	A	Bottom	44,3 mm [1.75 in]	42,5 mm [1.67 in]	Panel mount	914CE29-3	
	Silver	C	Bottom	30,3 mm [1.19 in]	28,5 mm [1.12 in]	dc-type, single keyway	914CE3-Q	
	Silver	C	Bottom	30,3 mm [1.19 in]	28,5 mm [1.12 in]	ac-type, two keyways	914CE3-Q1	

Note: part numbers are shown with 3 ft of cable. The -X indicates the number of feet of cable provided. 6-foot, 9-foot, and 12-foot lengths along with custom lengths, are also available.

MICRO SWITCH Miniature Precision Limit Switches, 914CE Series

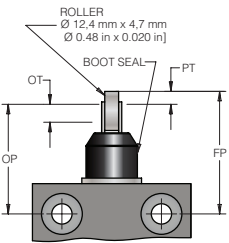
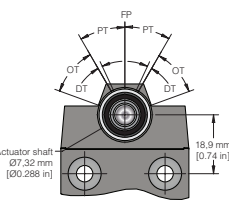
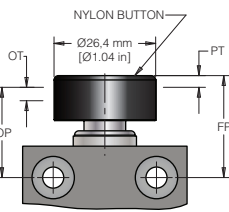
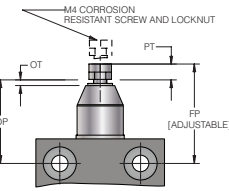
914CE55 • Boot Sealed Cross Roller Plunger		Contacts	Elec Rating	Cable Exit	Free Position (FP)	Operating Position (OP)	Options	Listing
 <p> Pretravel • 1,8 mm [0.071 in] Diff. travel • 0,1 mm [0.004 in] Overtravel • 3,0 mm [0.118 in] Oper. force • 22,2 N [5 in-lb] </p>	Silver	A	Bottom	36,2 mm [1.43 in]	34,4 mm [1.36 in]	–	914CE55-3	
914CE16 • Side Rotary		Contacts	Elec Rating	Cable Exit	Free Position (FP)	Operating Position (OP)	Options	Listing
 <p> Pretravel • 30° Diff. travel • 3° Overtravel • 40° Oper. force • 0,34 Nm [3 in-lb] </p>	Silver	A	Bottom	–	–	–	914CE16-3¹	
	Silver	A	Side	–	–	–	914CE16-3A¹	
	Silver	C	Bottom	–	–	ac-type, two keyways	914CE16-Q1¹	
	Silver	C	Bottom	–	–	dc-type, single keyway	914CE16-Q1¹	
	Silver	C	Side	–	–	ac-type, two keyways	914CE16-AQ1¹	
914CE22 • Manually Operated		Contacts	Elec Rating	Cable Exit	Free Position (FP)	Operating Position (OP)	Options	Listing
 <p> Pretravel • 1,8 mm [0.071 in] Diff. travel • 0,1 mm [0.004 in] Overtravel • 3,0 mm [0.118 in] Oper. force • 8,9 N [2 in-lb] </p>	Silver	A	Bottom	29,2 mm [1.15 in]	27,4 mm [1.08 in]	23,9 mm [0.94 in] dia. button	914CE22-3	
914CE19 • Adjustable Plunger		Contacts	Elec Rating	Cable Exit	Free Position (FP)	Operating Position (OP)	Options	Listing
 <p> Pretravel • 1,8 mm [0.071 in] Diff. travel • 0,1 mm [0.004 in] Overtravel • 3,0 mm [0.118 in] Oper. force • 17,5 N [5 lb] </p>	Silver	A	Bottom	Adjust. 33,8 mm to 40,8 mm [1.33 in to 1.61 in]	Adjust. 32 mm to 39 mm [1.26 in to 1.54 in]	–	914CE19-3	
	Gold	B	Bottom			–	914CE19-3G	
	Silver	A	Side			–	914CE19-3A	
	Silver	C	Bottom			ac-type, two keyways	914CE19-Q1	

¹ Switch operates on clockwise and counterclockwise rotation of lever shaft.

MICRO SWITCH Miniature Precision Limit Switches, 914CE Series

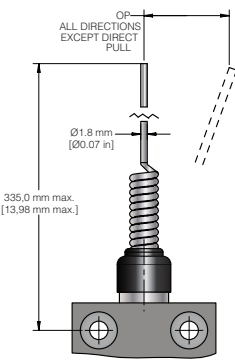
914CE20 • Random Motion Wire Actuator	Contacts	Elec Rating	Cable Exit	Free Position (FP)	Operating Position (OP)	Options	Listing
 <p data-bbox="341 441 613 504">Oper. point • 28 mm [1.10 in] max. Oper. force • 0,55 N [0.12 lb] max.</p>	Silver	A	Bottom	–	–	–	914CE20-3
	Silver	A	Side	–	–	–	914CE20-3A
	Silver	C	Bottom	–	–	dc-type, single keyway	914CE20-Q

Note: part numbers are shown with 3 ft of cable. The -X indicates the number of feet of cable provided. 6-foot, 9-foot, and 12-foot lengths along with custom lengths, are also available.

ADDITIONAL MATERIALS

- Product installation instructions
- Product range guide
- Product nomenclature tree
- Product application-specific information
 - Limit and enclosed switches application information
 - Limit and enclosed switches operating characteristics
 - Limit and enclosed switches reference standards
 - Limit and enclosed switches typical applications
 - Product flyer: CE Family Miniature Limit Switches

For more information

Honeywell Sensing and Internet of Things services its customers through a worldwide network of sales offices and distributors. For application assistance, current specifications, pricing or the nearest Authorized Distributor, visit sensing.honeywell.com or call:

Asia Pacific	+65 6355-2828
Europe	+44 (0) 1698 481481
USA/Canada	+1-800-537-6945

Honeywell Sensing and Internet of Things

9680 Old Bailes Road
Fort Mill, SC 29707
www.honeywell.com

WARNING **PERSONAL INJURY**

DO NOT USE these products as safety or emergency stop devices or in any other application where failure of the product could result in personal injury.

Failure to comply with these instructions could result in death or serious injury.

WARNING **MISUSE OF DOCUMENTATION**

- The information presented in this product sheet is for reference only. Do not use this document as a product installation guide.
- Complete installation, operation, and maintenance information is provided in the instructions supplied with each product.

Failure to comply with these instructions could result in death or serious injury.

Warranty/Remedy

Honeywell warrants goods of its manufacture as being free of defective materials and faulty workmanship during the applicable warranty period. Honeywell's standard product warranty applies unless agreed to otherwise by Honeywell in writing; please refer to your order acknowledgment or consult your local sales office for specific warranty details. If warranted goods are returned to Honeywell during the period of coverage, Honeywell will repair or replace, at its option, without charge those items that Honeywell, in its sole discretion, finds defective. **The foregoing is buyer's sole remedy and is in lieu of all other warranties, expressed or implied, including those of merchantability and fitness for a particular purpose. In no event shall Honeywell be liable for consequential, special, or indirect damages.**

While Honeywell may provide application assistance personally, through our literature and the Honeywell web site, it is buyer's sole responsibility to determine the suitability of the product in the application.

Specifications may change without notice. The information we supply is believed to be accurate and reliable as of this writing. However, Honeywell assumes no responsibility for its use.

Viton® is a registered trademark of DuPont Performance Elastomers L.L.C.

002381-7-EN | 7 | 06/18
© 2018 Honeywell International Inc. All rights reserved.

Honeywell