

**Honeywell**

# On-off 2-way/3-way FCU Electric Control Valves

## VS9 Series Installation Instructions

### Specifications

Actuator		Valve Body	
Operating Voltage	220 VAC ± 10 %, 110 VAC ± 10 %, 24 VAC ± 10 %, 50 / 60 Hz	Applicable Medium	Cold, hot water, or up to 50 % glycol
		Medium Temperature	0 °C – 94 °C
Control Mode	On-off, Spring return, normally closed when powered off	Operating Temperature	0 °C – 50 °C
Operating Temperature	0 °C – 50 °C	Operating Relative Humidity	10 % – 90 % RH
Operating Relative Humidity	10 % – 90 % RH, non-condensing	Storage Conditions	-20 °C – 65 °C, 10 % – 90 % RH non-condensing
Power	≤ 8 VA	Nominal Pressure	PN20
Operating Time	Open: ≤ 20 s; Close: ≤ 15 s	Materials	Valve body — HPb59-2
			Valve stem — HPb59-2
Protection Rating	IP20		Valve Flap — EPDM

### Ordering Information and Parameters

Models	Dimensions	Flow	Kv	Close-off Differential Pressure PSI (MPa)
VS92X15XX	1/2" (15 mm)	2-way	2.0 ± 10%	43 (0.3)
VS92X20XX	3/4" (20 mm)		2.4 ± 10%	36 (0.25)
VS92X25XX	1" (25 mm)		4.2 ± 10%	30 (0.2)
VS93X15XX	1/2" (15 mm)	3-way	2.0 ± 10%	43 (0.3)
VS93X20XX	3/4" (20 mm)		2.4 ± 10%	36 (0.25)
VS93X25XX	1" (25 mm)		4.2 ± 10%	30 (0.2)

### Product Naming

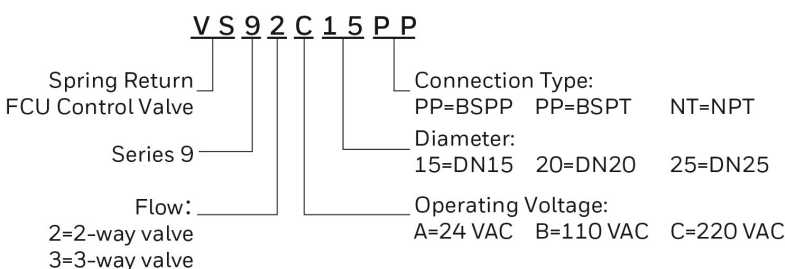

### Wiring Diagram

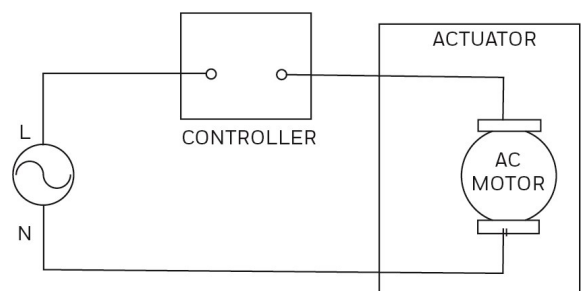

## Dimensions (mm)

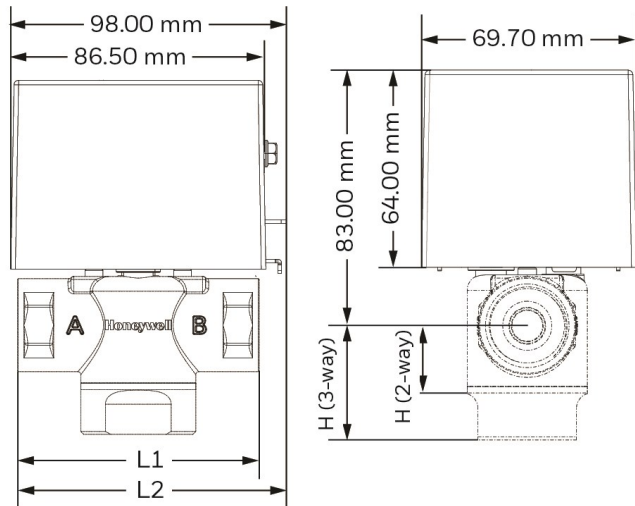

Models	Dimensions (mm)		
	L1	L2	H
VS92X15XX	78.00	89.00	19.00
VS92X20XX	82.00	91.00	21.50
VS92X25XX	88.00	94.00	24.50
VS93X15XX	78.00	89.00	34.00
VS93X20XX	82.00	91.00	37.00
VS93X25XX	88.00	94.00	45.00

## Installation Precautions

**Figure 1 2-way Normally Closed to the Coil**

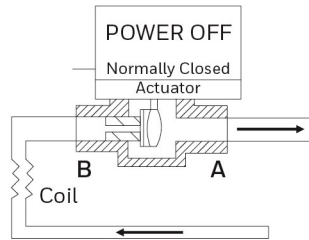

3-way is only used for normally closed configuration with port B. If it is used for normally open configuration, rotate the valve with 180°.

**Figure 2 3-way Valve in Mixing Configuration, Normally Closed to Coil**

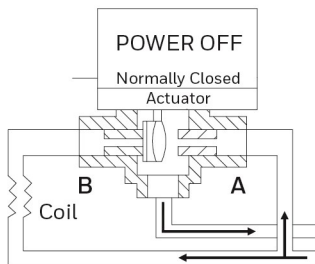

**Figure 3 3-way Valve in Diverting Configuration, Normally Closed to Coil**

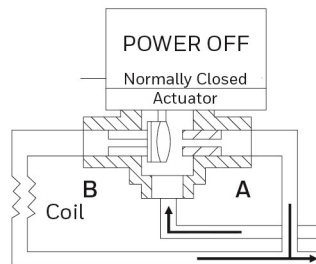

- The flow direction is from "B" to "A" ( see Figure 1).
- When installing the actuator of normal-closed valve, you must put the manual lever to the "Open" position.
- The manual lever of the actuator will move to the automatic position when you first operate the valve.
- VS9 series are designed for fully closed systems, which is not suggested to be used in an open system. In the open system, excessive dissolved oxygen and chlorine will erode the valve material and cause permanent damage.

Honeywell Environmental & Combustion Controls (Tianjin) Co.,Ltd.  
No. 158, NanHai Road Tianjin Economic-Technological Development Area  
Tianjin, 300457, P.R.C.

©2022 Honeywell International Inc. All rights reserved.

Subject to change without notice.

Rev. A

# VS9 Series Actuator

## Specifications

Operating Voltage	220 VAC ± 10 %, 110 VAC ± 10 %, 24 VAC ± 10 %, 50 / 60 Hz	Power	≤ 8 VA
Control Mode	On-Off, Spring return, normally closed when powered off	Operating Time	Open: ≤ 20 s ; Close: ≤ 15 s
Operating Temperature	0 °C – 50 °C		
Operating Relative Humidity	10 % – 90 % RH, non-condensing	Protection Rating	IP20

## Product Naming

Models	Operating Voltage
VS9ZZC00T	220 V, 50 / 60 Hz
VS9ZZB00T	110 V, 50 / 60 Hz
VS9ZZA00T	24 V, 50 / 60 Hz

## Dimensions

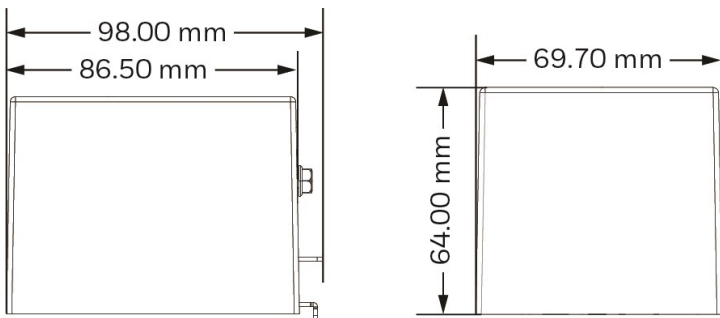

## Wiring Diagram

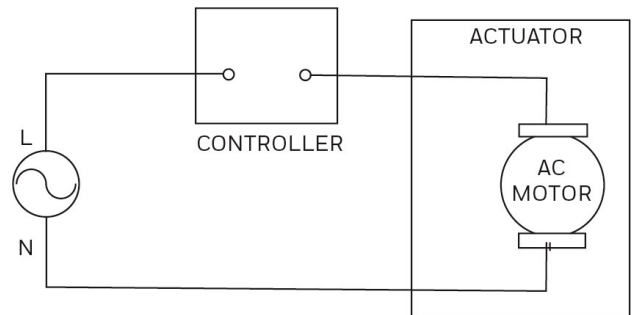

## Precautions

- When installing the actuator of normal-closed valve, you must put the manual lever to the “Open” position.
- The manual lever of the actuator will move to the automatic position when you first operate the valve.

Honeywell Environmental & Combustion Controls (Tianjin) Co.,Ltd.  
 No. 158, NanHai Road Tianjin Economic-Technological Development Area  
 Tianjin, 300457, P.R.C.

©2022 Honeywell International Inc. All rights reserved.

Subject to change without notice.

Rev. A