



MICRO SWITCH™  
Military-Grade Toggle Switches  
TL Series



# MICRO SWITCH™ TL Series Toggle Switches

Honeywell MICRO SWITCH™ TL Series toggle switches are military qualified to MIL-DTL-3950, specifications for sealed toggle switches. Quality construction features include a bonded seal between the toggle lever and bushing, and between the cover and case.

The robust design of the TL Series toggle is well-suited for many military, aerospace and other demanding applications where reliability is essential. These applications include environments where the panels are subjected to mechanical shock, vibration, and temperature extremes as well as environments with dust, splashing or hose-directed water.

TL Series toggle switches offer a variety of circuitry and pole options to easily integrate into a number of applications. A long history in military and aerospace applications has shown the TL Series toggle provides reliable performance with long operating life under the toughest conditions.

## *What makes our switches better?*

- MIL-DTL-3950 qualified switches available to meet military specifications
- Environmental sealing enables switches to withstand many demanding indoor and outdoor applications
- 1-, 2-, and 4-pole options for a variety of circuitry requirements
- 2- and 3-position, maintained and momentary toggle action to meet circuit and actuator requirements
- UL recognized, CSA certified, and CE approved for global use



***ATTENTION!!  
TL Series toggles are qualified  
for military duty!***

MILITARY QUALIFIED • GLOBAL APPROVALS  
MULTI-CIRCUITS • HIGH PERFORMANCE

# Features and Benefits

## MIL-QUALIFIED AND GLOBAL APPROVALS

**MIL-DTL-3950 qualified** switches are available to meet military/aerospace specifications. TL Series toggles' environmental sealing enables switches to withstand many demanding indoor and outdoor applications. Quality construction includes a bonded seal between the toggle lever and bushing, and between the cover and case that enables switches to **withstand may demanding conditions**. UL recognized, CSA certified, and CE approved for global use

### *Military-qualified listings*

## VARIETY OF CIRCUITRIES AND OPERATING ACTIONS

TL Series' **1, 2, and 4 pole options** meet a variety of circuitry requirements; while **2- and 3-position, maintained and momentary** toggle action, for a breadth of circuitry and actuator requirements. They thrive in a wide range of temperatures: -65 °C to 71 °C [-85 °F to 160 °F]

### *Locking levers reduce unintended actuation*

#### LOCKING LEVERS

Optional **lever locks** (pull-to-unlock) require two separate actions to actuate the switch in order to prevent unintended actuation

#### MULTIPLE CONNECTION OPTIONS

MICRO SWITCH™ TL Series toggles offer **three popular termination options**: screw, solder lugs, and IWTS (Integrated Wire Termination Systems)

#### EASILY CONTROLS LOW-VOLTAGE DC APPLICATIONS

Toggle switches available with a choice of **silver alloy or gold-plated contacts** to handle a variety of electrical load requirements

#### INNOVATIVE PRODUCT DESIGN

Engineered step-design case provides added space between terminals to **prevent shorting**

#### ROBUST CONSTRUCTION

Built from **military-grade components** to achieve MIL-DTL-3950 requirements

## Potential Applications



### **MILITARY AND COMMERCIAL AIRCRAFT AND HELICOPTERS**

Used in fixed wing aircraft and helicopter flight decks. Honeywell has a long history of providing TL Series toggle switches in commercial and military aircraft.

### **AVIATION GROUND SUPPORT EQUIPMENT**

Used to turn on and operate various components of aviation ground support equipment, such as pumps, lights, and lift platforms.



### **MILITARY LAND VEHICLES (TRACK AND WHEELED VEHICLES)**

Used in military land vehicles to control lights, pumps, arming equipment, and movement control of lifts/ramps, etc.

### **CONSTRUCTION EQUIPMENT**

Often used on road milling, road pavers, trenchers, and stump cutters to operate movement of machinery and/or turn on lights, pumps, etc.



# MICRO SWITCH™ Military-Grade Toggle Switches

**Table 1. Specifications**

Characteristic	Parameter
Description	military-grade toggle switch
Sealing	qualified to MIL-DTL-3950
Operating temperature	-65 °C to 71 °C [-85 °F to 160 °F]
Actuators	standard, locking, special design, tab
Action	2- or 3- position; momentary and maintained
Mounting	Bushing 15/32 in (0.47 in) Ø
Circuitry	SPST, SPDT, DPST, DPDT, 4PST, 4PDT
Terminations	IWTS, solder, screw, quick-connect, leadwire
Contacts	Silver alloy or gold-plated
Amp rating	Up to 20 A, ac and dc capability
Approvals	UL, CSA, CE
Measurement	26,7 mm H x 33,5 mm W x 22,6 mm D [1.05 in H x 1.32 in W x 0.89 in D]

**Table 2. UL and CSA Electrical Ratings**

Rating code	Electrical rating
L192	10 amps, 125, 250, 277 Vac; ¼ Hp, 125 Vac; ½ Hp, 250, 277 Vac; 3 amps, 125 Vac “L”
L191	15 amps, 125, 250, 277 Vac; ½ Hp, 125 Vac; 1 Hp, 250, 277 Vac; 5 amps, 125 Vac “L”

**Table 3. Electrical Ratings (in amperes)**

Electrical rating code	28 Vdc			115 Vdc	250 Vdc	115 Vac, 60 Hz & 400 Hz Max.			230 Vac
	Ind.	Res.	Lamp	Res.	Res.	Ind.	Res.	Lamp	Res.
1	15	20	5	0.75	0.5	10	15	3	6
2	10	15	4	0.75	0.5	7	15	2	6
3	15	20	7	0.75	0.5	15	15	4	6
4	10	18	5	0.75	0.5	8	11	2	6
5	12	20	5	0.75	0.5	15	15	4	6
6	10	18	4	0.75	0.5	8	11	2	6



# TL Series

## TERMINAL CIRCUIT IDENTIFICATION

Terminal identifications are referred to in the order guides to indicate which circuits are made in each toggle position (i.e., 1-2 refers to circuit closure through terminals 1 and 2).

### One Pole

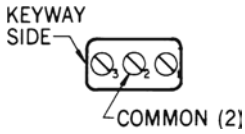

### Two Pole

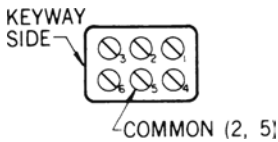

### Four Pole

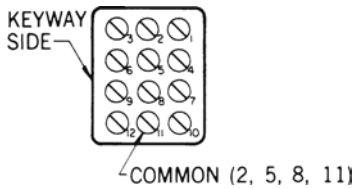

## TERMINALS

In addition to the screw terminal listings in the order guides, IWTS (Integrated Wire Termination Systems) versions and solder current terminals are available.

IWTS provides a reliable, completely serviceable unit which meets MIL-DTL-3950 requirements. IWTS improves maintainability since wiring bundles need not be disturbed. Leads are quickly and easily assembled or removed with an insert-extract tool.

A unique three-rib (grommet style) elastomer seal protects the lead connections without potting. There are no exposed metal terminals.

Versions available that will accept No. 16 wire with M39029/1-102 contact pins or No. 20 wire with MS39029/1-101 contact pins. Connections are resistant to shock, vibration, and high pull-out force.

## SPECIAL CIRCUITRIES

Catalog listings with -10, -50, and -70 suffix numbers, as shown in the order guides, have special "on-on-on" circuits, as illustrated below. TLs with -12 suffix are the same as -50 except the keyway position is maintained, and the center position circuits 2-3 and 4-5 are made. -72 is the same as -50 except that the opposite keyway position is momentary, and in the center position circuits 2-3 and 4-5 are made.

### -10 CIRCUITRY

No of poles	Keyway Side Maint. Position	Center Maint. Position	Opposite Keyway Maint. Position
2			
4			

### -50 CIRCUITRY

No of poles	Keyway Side Maint. Position	Center Maint. Position	Opposite Keyway Maint. Position
2			
4			

### -70 CIRCUITRY

No of poles	Keyway Side Maint. Position	Center Maint. Position	Opposite Keyway Maint. Position
2			
4			

# MICRO SWITCH™ Military-Grade Toggle Switches

## TL (SCREW TERMINAL) 2-POSITION ORDER GUIDE

No. of poles	Circuits Made with Toggle At:				Standard Toggle		Pull-to-Unlock Toggle	
	Keyway Position	Opposite Keyway	Elect. Rating Code	UL Rating Code	Catalog Listing	Military Number	Add Suffix to Standard Toggle Listing <sup>Δ</sup>	Military Number**
1	OFF	2-3	1	L191	1TL1-2	MS24523-22	D, F, G	MS24658-22
	OFF*	2-3	2	L192	1TL1-4	MS24523-29	F	MS24658-29
	1-2*	OFF	2	L192	1TL1-6	MS24523-30	F	MS24658-30
	1-2	2-3	1	L191	1TL1-3	MS24523-23	D, F, G	MS24658-23
	1-2*	2-3	2	L192	1TL1-8	MS24523-26	F	MS24658-26
2	OFF	2-3, 5-6	3	L191	2TL1-2	MS24524-22	D, F, G	MS24659-22
	OFF*	2-3, 5-6	4	L192	2TL1-4	MS24524-29	F	MS24659-29
	1-2, 4-5*	OFF	4	L192	2TL1-6	MS24524-30	F	MS24659-30
	1-2, 4-5	2-3, 5-6	3	L191	2TL1-3	MS24524-23	D, F, G	MS24659-23
	1-2, 4-5*	2-3, 5-6	4	L192	2TL1-8	MS24524-26	F	MS24659-26
4	OFF	2-3, 5-6, 8-9, 11-12	5	L191	4TL1-2	MS24525-22	D, F, G	MS24660-22
	OFF*	2-3, 5-6, 8-9, 11-12	6	L192	4TL1-4	MS24525-29	F	MS24660-29
	1-2, 4-5, 7-8, 10-11*	OFF	6	L192	4TL1-6	MS24525-30	F	MS24660-30
	1-2, 4-5, 7-8, 10-11	2-3, 5-6, 8-9, 11-12	5	L191	4TL1-3	MS24525-23	D, F, G	MS24660-23
	1-2, 4-5*, 7-8, 10-11	2-3, 5-6, 8-9, 11-12	6	L192	4TL1-8	MS24525-26	F	MS24660-26

\* These positions are momentary. All others are maintained.

\*\* Also add the appropriate suffix to the military number.

<sup>Δ</sup> See page 12 for locking configurations.

## PULL-TO-UNLOCK OPTION

When ordering pull-to-unlock toggle listings (see page 12 for configurations), add the suffix letter shown in the chart on page XXX to the standard toggle listing or the MS part number. For example, to order a 1TL1-1 pull-to-unlock toggle switch with the lever locked in the center position, add the letter **E** (i.e., 1TL1-1**E**, MS24658-21**E**)



## SOLDER TURRET TERMINAL VERSION

11TL, 12TL, and 14TL type switches with solder current terminals are qualified to MIL-DTL-3950. They have the same circuitry and electrical ratings as their 1TL, 2TL, and 4TL counterparts. For example, an 11TL1-2 is the same as a 1TL1-2, except it has solder turret terminals instead of screw terminals.

Circuitry	Type	Standard Lever	Lever Lock
One pole	11TL	MS27734	MS27737
Two pole	12TL	MS27735	MS27738
Four pole	14TL	MS27736	MS27739

# TL Series

## TL (SCREW TERMINAL) 3-POSITION ORDER GUIDE

No. of poles	Circuits Made with Toggle At:					Standard Toggle		Pull-to-Unlock Toggle	
	Keyway Position	Center Position	Opposite Keyway	Elect. Rating Code	UL/CSA Rating Code	Catalog Listing	Military Number	Add Suffix to Standard Toggle Listing <sup>Δ</sup>	Military Number <sup>***</sup>
1	1-2	OFF	2-3	1	L191	1TL1-1	MS24523-21	ALL TYPES	MS24658-21
	1-2*	OFF	2-3	2	L192	1TL1-5	MS24523-31	E, F, K, L, M, N	MS24658-31
	1-2*	OFF	2-3*	2	L192	1TL1-7	MS24523-27	E, L, N	MS24658-27
	NONE**	OFF	2-3	1	L191	1TL1-21	MS24523-24	E, F, K, M	MS24658-24
	NONE**	1-2	2-3	1	L192	1TL1-31	MS24523-33	E, F, K, M	MS24658-33
	NONE**	1-2	2-3*	2	L192	1TL1-51	MS24523-32	E	MS24658-32
	1-2*	OFF	NONE**	2	L192	1TL1-61	MS24523-25	E	MS24658-28
2	1-2, 4-5	OFF	2-3, 5-6	3	L191	2TL1-1	MS24524-21	ALL TYPES	MS24659-21
	1-2, 4-5*	OFF	2-3, 5-6	4	L192	2TL1-5	MS24524-31	E, F, K, L, M, N	MS24659-31
	1-2, 4-5*	OFF	2-3, 5-6*	4	L192	2TL1-7	MS24524-27	E, L, N	MS24659-27
	NONE**	OFF	2-3, 5-6	3	L191	2TL1-21	MS24524-24	E, F, K, M	MS24659-24
	NONE**	1-2, 4-5	2-3, 5-6	3	L191	2TL1-31	MS24524-33	E, F, K, M	MS24659-33
	NONE**	1-2, 4-5	2-3, 5-6*	4	L192	2TL1-51	MS24524-32	E	MS24659-32
	1-2, 4-5*	OFF	NONE**	4	L192	2TL1-61	MS24524-28	E	MS24659-28
	1-2, 4-5	1-2, 5-6	2-3, 5-6	3	L191	2TL1-10	MS27407-4	ALL TYPES	MS27408-4
	1-2, 4-5*	1-2, 5-6	2-3, 5-6	4	L192	2TL1-50	MS27407-5	E, F, K, L, M, N	MS27408-5
1-2, 4-5*	1-2, 5-6	2-3, 5-6*	4	L192	2TL1-70	MS27407-6	E, L, N	MS27408-6	
4	1-2, 4-5, 7-8, 10-11	OFF	2-3, 5-6, 8-9, 11-12	5	L191	4TL1-1	MS24525-21	ALL TYPES	MS24660-21
	1-2, 4-5, 7-8, 10-11*	OFF	2-3, 5-6, 8-9, 11-12	6	L192	4TL1-5	MS24525-31	E, F, K, L, M, N	MS24660-31
	1-2, 4-5, 7-8, 10-11*	OFF	2-3, 5-6, 8-9, 11-12*	6	L192	4TL1-7	MS24525-27	E, L, N	MS24660-27
	NONE**	OFF	2-3, 5-6, 8-9, 11-12	5	L191	4TL1-21	MS24525-24	E, F, K, M	MS24660-24
	NONE**	1-2, 4-5, 7-8, 10-11	2-3, 5-6, 8-9, 11-12	5	L191	4TL1-31	MS24525-33	E, F, K, M	MS24660-33
	NONE**	1-2, 4-5, 7-8, 10-11	2-3, 5-6, 8-9, 11-12*	6	L192	4TL1-51	MS24525-32	E	MS24660-32
	1-2, 4-5, 7-8, 10-11*	OFF	NONE**	6	L192	4TL1-61	MS24525-38	E	MS24660-28
	1-2, 4-5, 7-8, 10-11	2-3, 4-5	2-3, 5-6, 8-9, 11-12	5	L191	4TL1-10	–	ALL TYPES	–
	1-2, 4-5, 7-8, 10-11*	2-3, 4-5, 7-8, 11-12	2-3, 5-6, 8-9, 11-12	6	L192	4TL1-50	MS27406-2	E, F, K, L, M, N	MS27409-2
	1-2, 4-5, 7-8, 10-11*	2-3, 4-5	2-3, 5-6, 8-9, 11-12*	6	L192	4TL1-70	–	E, L, N	–
	1-2, 4-5, 7-8, 10-11	2-3, 4-5, 7-8, 11-12	2-3, 5-6, 8-9, 11-12	5	L191	4TL1-12	MS27406-1	ALL TYPES	MS27409-1
1-2, 4-5, 7-8, 10-11*	2-3, 4-5, 7-8, 11-12	2-3, 5-6, 8-9, 11-12*	6	L192	4TL1-72	MS27406-3	E, L, N	MS27409-3	

\* These positions are momentary. All others are maintained.

\*\* Toggle lever is blocked from these products. Toggle becomes 2-position, with center being one extreme position.

\*\*\* Also add appropriate suffix letter to military number

<sup>Δ</sup> See page 12 for locking configurations.



# MICRO SWITCH™ Military-Grade Toggle Switches

## TL (IWTS TERMINATION) 2-POSITION ORDER GUIDE

No. of poles	Circuits Made with Toggle At:			Elect. Rating Code	UL Rating Code	No. 16 Termination		No. 20 Termination	
	Keyway Position	Opposite Keyway				Catalog Listing	Military Number	Catalog Listing	Military Number
1	OFF	2-3		1	L191	101TL1-2	MS27722-22	101TL2-2	MS27784-22
	OFF*	2-3		2	L192	101TL1-4	MS27722-29	101TL2-4	MS27784-29
	1-2*	OFF		2	L192	101TL1-6	MS27722-30	101TL2-6	MS27784-30
	1-2	2-3		1	L191	101TL1-3	MS27722-23	101TL2-3	MS27784-23
	1-2*	2-3		2	L192	101TL1-8	MS27722-26	101TL2-8	MS27784-26
2	OFF	2-3, 5-6		3	L191	102TL1-2	MS27723-22	102TL2-2	MS27785-22
	OFF*	2-3, 5-6		4	L192	102TL1-4	MS27723-29	102TL2-4	MS27785-29
	1-2, 4-5*	OFF		4	L192	102TL1-6	MS27723-30	102TL2-6	MS27785-30
	1-2, 4-5	2-3, 5-6		3	L191	102TL1-3	MS27723-23	102TL2-3	MS27785-23
	1-2, 4-5*	2-3, 5-6		4	L192	102TL1-8	MS27723-26	102TL2-8	MS27785-26
4	OFF	2-3, 5-6, 8-9, 11-12		5	L191	104TL1-2	MS27724-22	104TL2-2	MS27786-22
	OFF*	2-3, 5-6, 8-9, 11-12		6	L192	104TL1-4	MS27724-29	104TL2-4	MS27786-29
	1-2, 4-5, 7-8, 10-11*	OFF		6	L192	104TL1-6	MS27724-30	104TL2-6	MS27786-30
	1-2, 4-5, 7-8, 10-11	2-3, 5-6, 8-9, 11-12		5	L191	104TL1-3	MS27724-23	104TL2-3	MS27786-23
	1-2, 4-5, 7-8, 10-11*	2-3, 5-6, 8-9, 11-12		6	L192	104TL1-8	MS27724-26	104TL2-8	MS27786-26

## TL (IWTS TERMINATION) 3-POSITION ORDER GUIDE

No. of poles	Circuits Made with Toggle At:				Elect. Rating Code	UL/CSA Rating Code	No. 16 Termination		No. 20 Termination	
	Keyway Position	Center Position	Opposite Keyway				Catalog Listing	Military Number	Catalog Listing	Military Number
1	1-2	OFF	2-3		1	L191	101TL1-1	MS27722-21	101TL2-1	MS27784-21
	1-2*	OFF	2-3		2	L192	101TL1-5	MS27722-31	101TL2-5	MS27784-31
	1-2*	OFF	2-3*		2	L192	101TL1-7	MS27722-27	101TL2-7	MS27784-27
2	1-2, 4-5	OFF	2-3, 5-6		3	L191	102TL1-1	MS27723-21	102TL2-1	MS27785-21
	1-2, 4-5*	OFF	2-3, 5-6		4	L192	102TL1-5	MS27723-31	102TL2-5	MS27785-31
	1-2, 4-5*	OFF	2-3, 5-6*		4	L192	102TL1-7	MS27723-6	102TL2-7	MS27785-27
4	1-2, 4-5, 7-8, 10-11	OFF	2-3, 5-6, 8-9, 11-12		5	L191	104TL1-1	MS27724-21	104TL2-1	MS27786-21
	1-2, 4-5, 7-8, 10-11*	OFF	2-3, 5-6, 8-9, 11-12		6	L192	104TL1-5	MS27724-31	104TL2-5	MS27786-31
	1-2, 4-5, 7-8, 10-11*	OFF	2-3, 5-6, 8-9, 11-12*		6	L192	104TL1-7	MS27724-27	104TL2-7	MS27786-27

\* These positions are momentary. All others are maintained.

NOTE: For TL switches featuring IWTS termination and a "pull-to-unlock" lever option, contact a Honeywell Sensing and Control representative at 1-800-537-6945.

## TL SERIES 1-POLE STANDARD ACTUATOR OPTIONS, TERMINALS, & DIMENSIONS

Note: Three-position switches shown

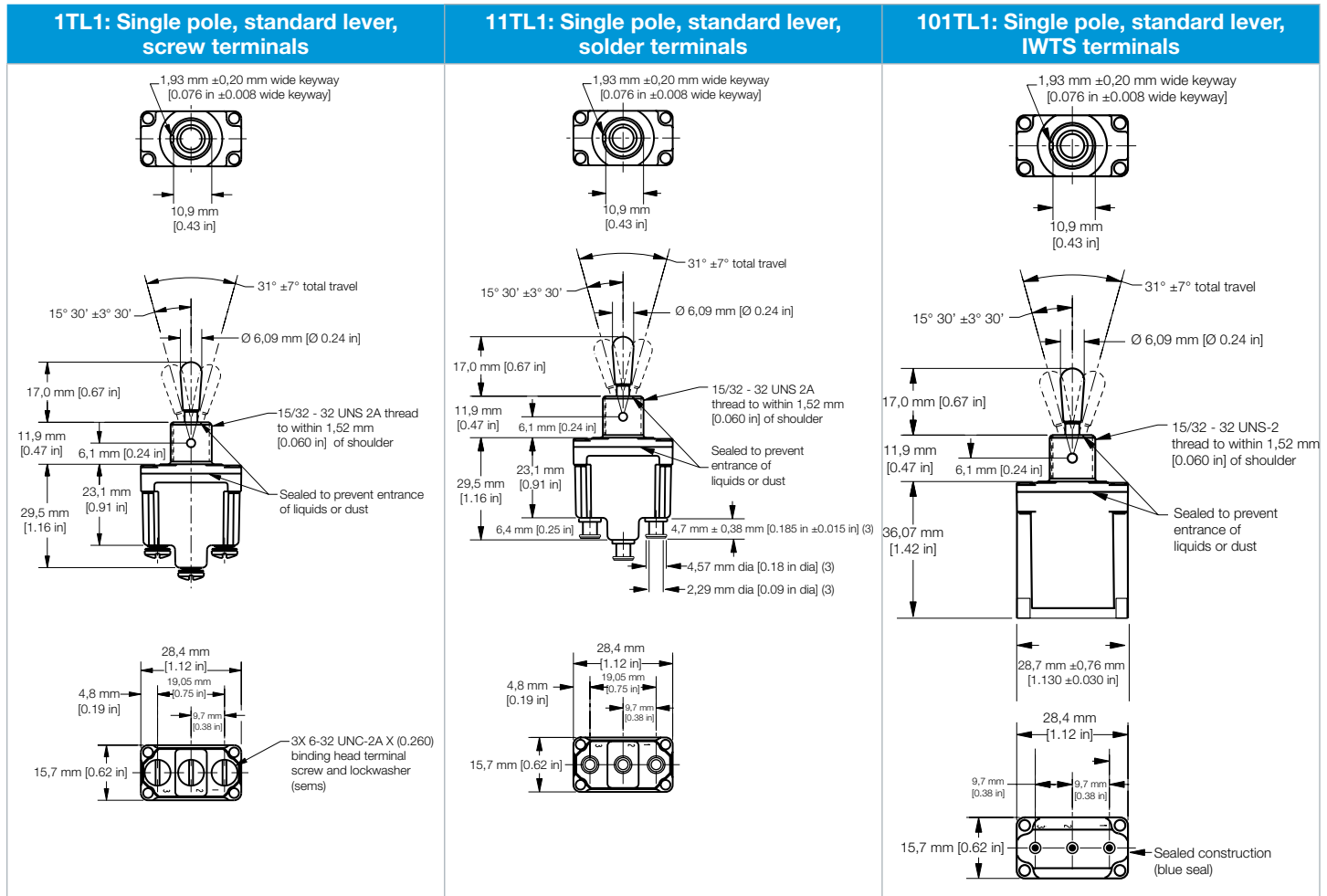

### Locking lever dimensions for single pole TL toggles

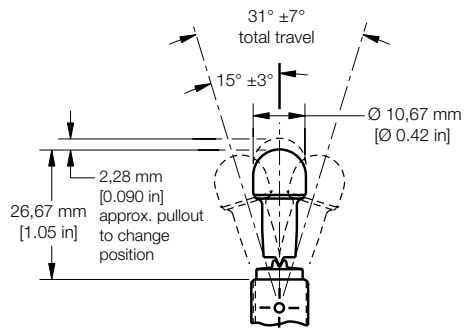

# MICRO SWITCH™ Military-Grade Toggle Switches

## TL SERIES 2-POLE STANDARD ACTUATOR OPTIONS, TERMINALS, & DIMENSIONS

Note: Three-position switches shown

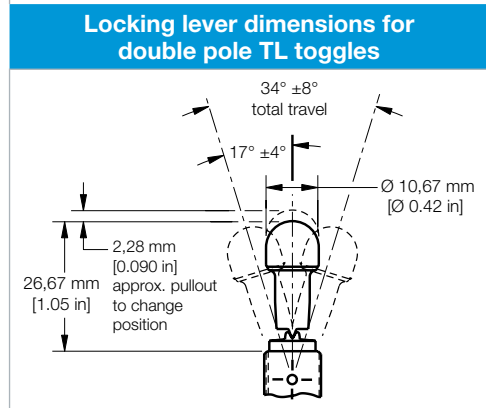
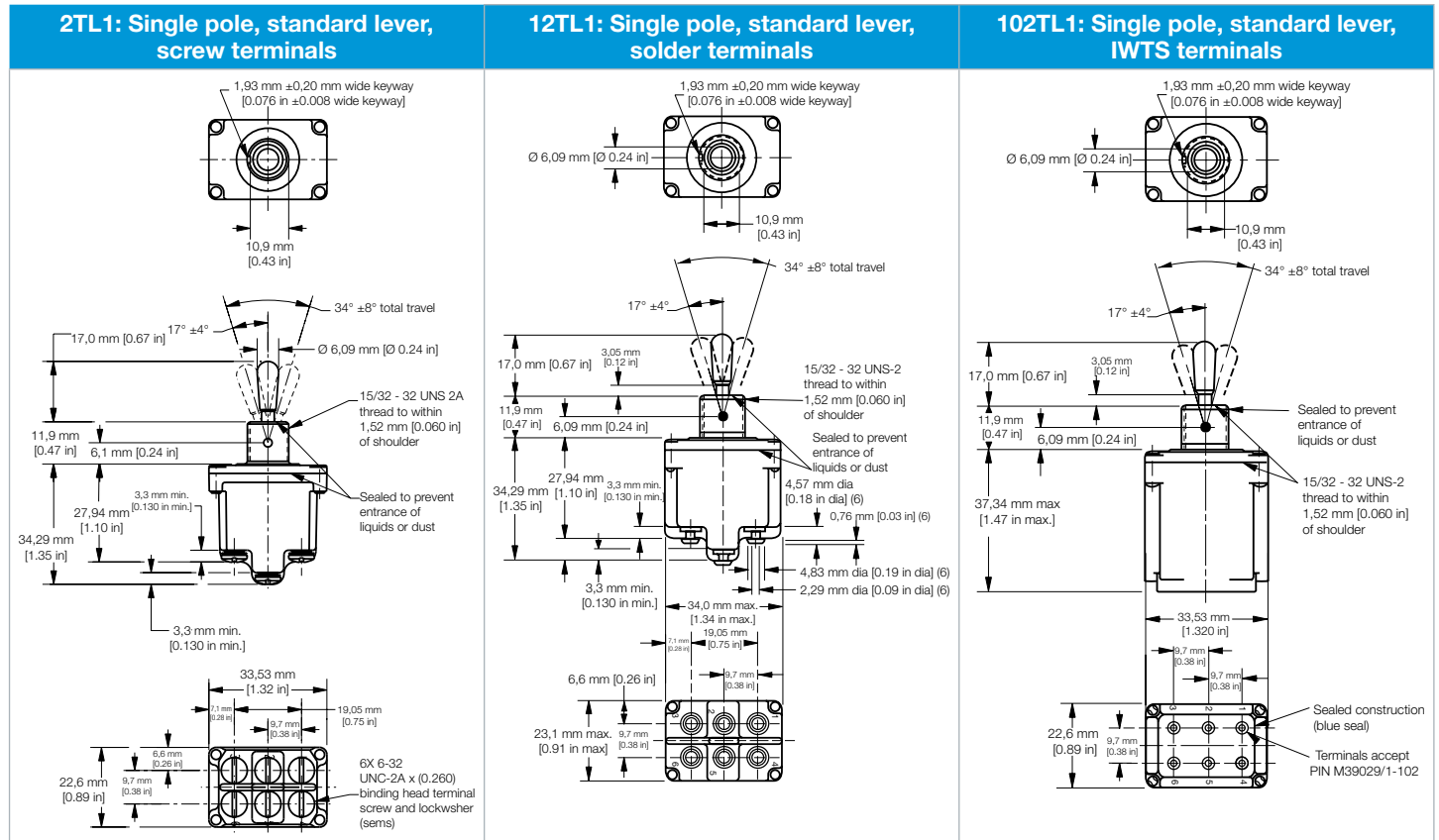





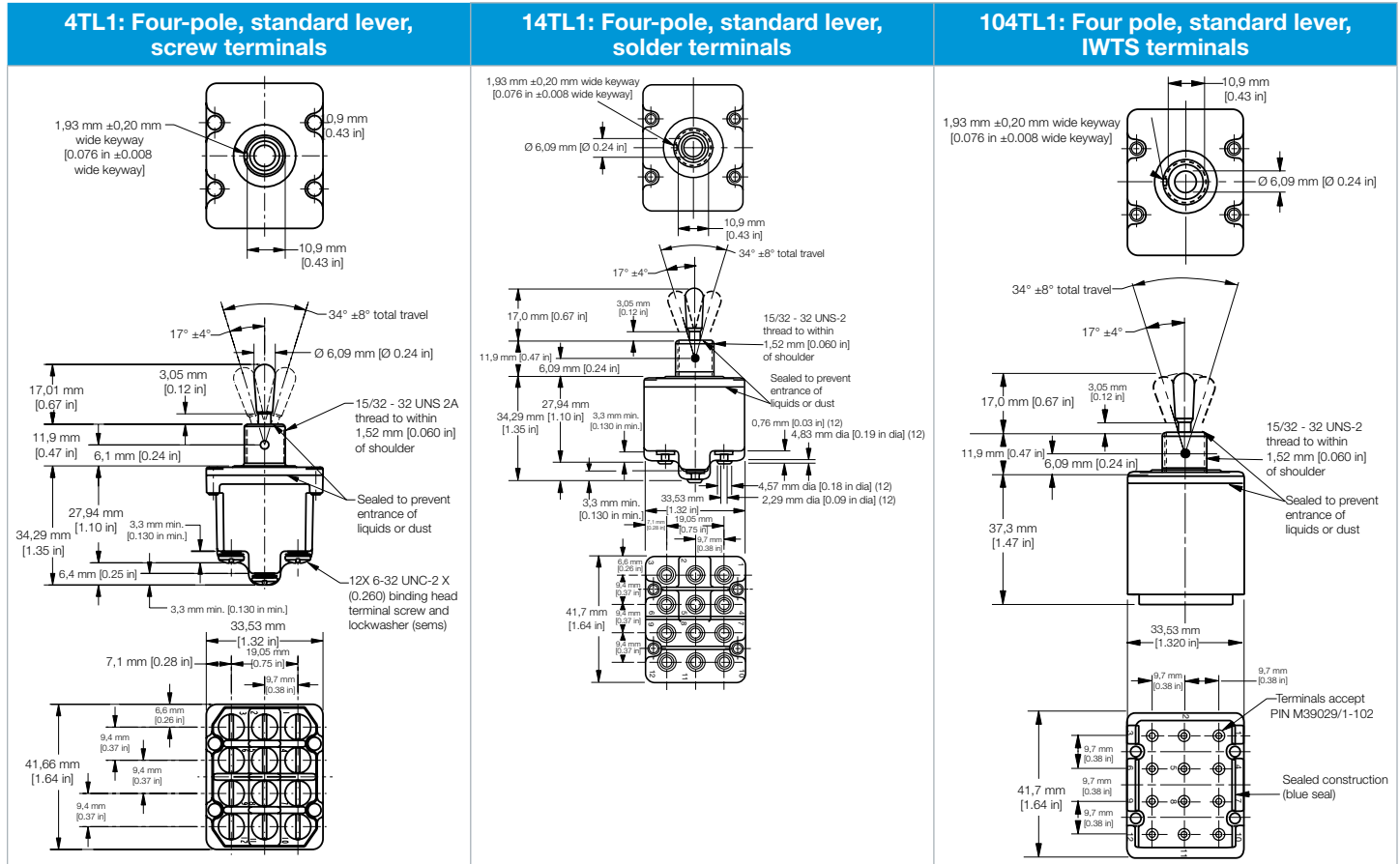







## TL SERIES 4-POLE STANDARD ACTUATOR OPTIONS, TERMINALS, & DIMENSIONS

Note: Three-position switches shown



# MICRO SWITCH™ Military-Grade Toggle Switches

## MICRO SWITCH™ TL™ SERIES LOCKING CONFIGURATIONS

<p><b>A</b></p>  <p>Locked In Three Positions</p>	<p><b>B</b></p>  <p>Locked In Center and Extreme Position (Keyway Side)</p>	<p><b>D</b></p>  <p>Locked Out Of Center Position</p>	<p><b>E</b></p>  <p>Locked In Center Position</p>	<p><b>F</b></p>  <p>Locked In Extreme Position (Opposite Keyway)</p>	<p><b>G</b></p>  <p>Locked In Extreme Position (Keyway Side)</p>	<p><b>H</b></p>  <p>Locked Out Of Center And Extreme Position (Keyway Side)</p>
<p><b>J</b></p>  <p>Locked Out Of Center And Extreme Position (Opposite Keyway)</p>	<p><b>K</b></p>  <p>Locked In Center And Extreme Position (Opposite Keyway)</p>	<p><b>L</b></p>  <p>Locked Out Of Extreme Position (Keyway Side)</p>	<p><b>M</b></p>  <p>Locked Out Of And Into Extreme Position (Opposite Keyway)</p>	<p><b>N</b></p>  <p>Locked Out Of Extreme Position (Opposite Keyway)</p>	<p><b>P</b></p>  <p>Locked Out Of And Into Extreme Position (Keyway Side)</p>	

## ADDITIONAL INFORMATION

The following associated literature is available on the Web ([sensing.honeywell.com](http://sensing.honeywell.com)):

- Product installation instructions
- Product range guide
- Product application-specific information
  - Flight deck toggle switches
  - Sensors and switches in front loaders
  - Sensors and switches in mobile cranes
  - Sensors and switches in oil rig applications

### Find out more

Honeywell serves its customers through a worldwide network of sales offices, representatives and distributors. For application assistance, current specifications, pricing or name of the nearest Authorized Distributor, contact your local sales office.

To learn more about Honeywell's sensing and switching products, call **+1-815-235-6847** or **1-800-537-6945**, visit **[sensing.honeywell.com](http://sensing.honeywell.com)**, or e-mail inquiries to **[info.sc@honeywell.com](mailto:info.sc@honeywell.com)**

### Honeywell Sensing and Productivity Solutions

9680 Old Bailes Road  
Fort Mill, SC 29707  
[honeywell.com](http://honeywell.com)

005430-2-EN IL50 GLO  
May 2016  
Copyright © 2016 Honeywell International Inc. All rights reserved.

### WARNING

#### PERSONAL INJURY

**DO NOT USE** these products as safety or emergency stop devices or in any other application where failure of the product could result in personal injury.

**Failure to comply with these instructions could result in death or serious injury.**

### WARNING

#### MISUSE OF DOCUMENTATION

- The information presented in this product sheet is for reference only. Do not use this document as a product installation guide.
- Complete installation, operation, and maintenance information is provided in the instructions supplied with each product.

**Failure to comply with these instructions could result in death or serious injury.**

## WARRANTY/REMEDY

Honeywell warrants goods of its manufacture as being free of defective materials and faulty workmanship. Honeywell's standard product warranty applies unless agreed to otherwise by Honeywell in writing; please refer to your order acknowledgement or consult your local sales office for specific warranty details. If warranted goods are returned to Honeywell during the period of coverage, Honeywell will repair or replace, at its option, without charge those items it finds defective. **The foregoing is buyer's sole remedy and is in lieu of all other warranties, expressed or implied, including those of merchantability and fitness for a particular purpose. In no event shall Honeywell be liable for consequential, special, or indirect damages.**

While we provide application assistance personally, through our literature and the Honeywell website, it is up to the customer to determine the suitability of the product in the application.

Specifications may change without notice. The information we supply is believed to be accurate and reliable as of this printing. However, we assume no responsibility for its use.

# Honeywell



# Mouser Electronics

Authorized Distributor

Click to View Pricing, Inventory, Delivery & Lifecycle Information:

## Honeywell:

[101TL1-2](#) [102TL1-1](#) [102TL1-3](#) [102TL2-2](#) [102TL2-8](#) [104TL1-1](#) [11TL1-1](#) [11TL1-2](#) [11TL1-3](#) [12TL1-1](#) [12TL1-10](#)  
[12TL1-2](#) [12TL1-2D](#) [12TL1-3](#) [12TL1-7](#) [MS24523-30](#) [14TL1-1](#) [14TL1-12](#) [14TL1-12E](#) [14TL1-1A](#) [14TL1-2](#) [14TL1-31](#)  
[14TL1-3D](#) [14TL1-3G](#) [1TL1-1A](#) [1TL1-1B](#) [1TL1-1D](#) [1TL1-1E](#) [1TL1-1F](#) [1TL1-1G](#) [1TL1-1H](#) [1TL1-1K](#) [1TL1-1L](#)  
[1TL1-1M](#) [1TL1-1N](#) [1TL1-1P](#) [1TL1-2](#) [1TL1-2D](#) [1TL1-2G](#) [1TL1-3](#) [1TL1-31E](#) [1TL1-3D](#) [1TL1-3F](#) [1TL1-3G](#) [1TL1-4](#)  
[1TL1-5](#) [1TL1-51](#) [1TL1-6](#) [1TL1-61](#) [1TL1-7](#) [1TL1-7E](#) [1TL1-7L](#) [1TL1-7N](#) [1TL1-8](#) [2TL1-1](#) [2TL1-10](#) [2TL1-10A](#) [2TL1-](#)  
[1A](#) [2TL1-1N](#) [2TL1-2](#) [2TL1-21](#) [2TL1-2D](#) [2TL1-2F](#) [2TL1-3](#) [2TL1-31](#) [2TL1-3D](#) [2TL1-3F](#) [2TL1-3G](#) [2TL1-4](#) [2TL1-5](#)  
[2TL1-50](#) [2TL1-51](#) [2TL1-61](#) [2TL1-6F](#) [2TL1-7](#) [2TL1-70](#) [2TL1-7E](#) [2TL1-8](#) [4TL1-1](#) [4TL1-12A](#) [4TL1-12B](#) [4TL1-12E](#)  
[4TL1-12L](#) [4TL1-12M](#) [4TL1-12P](#) [4TL1-1A](#) [4TL1-1D](#) [4TL1-1E](#) [4TL1-1L](#) [4TL1-1M](#) [4TL1-1N](#) [4TL1-1P](#) [4TL1-2](#) [4TL1-](#)  
[21](#) [4TL1-21F](#) [4TL1-21K](#) [4TL1-2D](#) [4TL1-2F](#) [4TL1-2G](#) [4TL1-3](#)